

Transportation



The shuttle system is an innovative transport system. It can be used anywhere it is required.

Since storage in the shuttle transport trolley or fixed shuttle cabinet is possible, there is no need to manually reload the individual sterile equipment systems at the transfer points. Depending on the size of the shuttle system, several 100 kg of sterile equipment are placed into the shuttle slide-in rack once after packing, and brought to and through the autoclave this way. They are then stored in the corresponding storage systems until use.

High quality: The fully welded transport trolley, the slide-in rack, and the transfer trolley are seamlessly constructed and especially robust.

Hygienic: The doors have a dust-proof seal, reducing the risk of recontamination.

Manoeuvrable: The handle positions on the sides permit better power transmission by the user, so that even a fully loaded transport trolley is easy to manoeuvre.

Practical: Depending on the required storage duration, storage can take place open on a platform or enclosed in a MEGAPROGRESS functional cabinet.

User-friendly: Frontal docking is secure and easy to handle. Secure docking is always possible.
The lock can easily be released by hand.

Changing direction: The shuttle transport system can be moved in two directions. This makes it compatible with any autoclave.



Shuttle System 3 StU

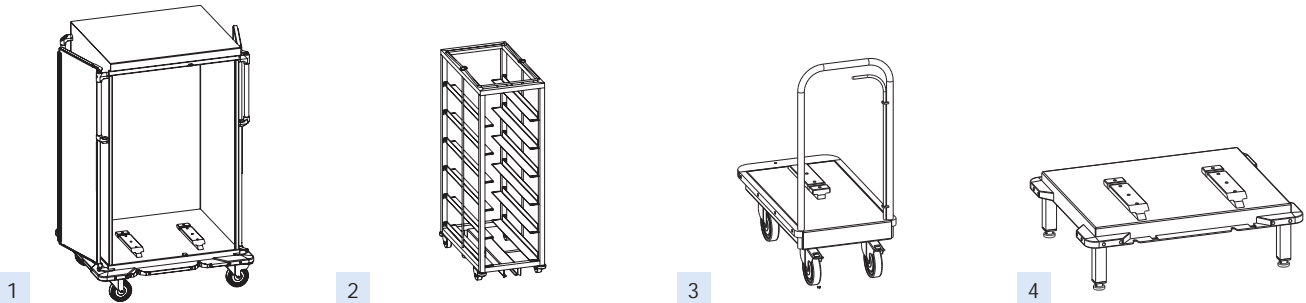

	Description	Dimensions (W x D x H)	Item no.
1	Shuttle transport trolley 2 x 3 StU		
	<p>Single-wall transport trolley made of CNS 18/10 to hold 2 slide-in racks 3 StU Guided and locked with 2 T-profiles.</p> <p>2 double-walled folding doors with circumferential seal and stop rail, door with 270° opening angle, lockable at 255° and 270°, lockable via knob</p> <p>4 push handles mounted vertically on the sides</p> <p>4 conductive swivel castors, Ø 160 mm, 2 of them lockable, washing bay compatible, suitable for outdoor transportation with full rubber tires</p>	939 x 812 x 1509 mm	542 879
2	3 StU slide-in shelf		
	<p>Slide-in rack made of CNS 18/10, 25 x 25 mm rectangular tubing, for storage and transport of 3 StU sterile equipment</p> <p>Safety catch to lock the slide-in rack in the T-profile</p> <p>1 section to hold 3 StU max., 3 pairs of removable support brackets</p> <p>4 fixed castors, Ø 80 mm, can be sterilized</p>	375 x 635 x 1091 mm	542 512
3	3 StU transfer trolley		
	<p>Transfer trolley made of CNS 18/10, for transportation of a 3 StU shuttle slide-in rack</p> <p>The slide-in rack is guided and locked to the platform via a T-profile, equipped with 1 hook underneath for safe frontal docking of the transfer trolley to the transport trolley</p> <p>1 straight push handle on the long side, three-sided bumper</p> <p>4 conductive swivel castors Ø 160 mm, 2 of them lockable</p>	415 x 734 x 932 mm	542 880
4	Free-standing lower frame for 2 x 3 StU		
	<p>CNS 18/10 platform with 4 legs</p> <p>2 slide-in racks (3 StU) are guided and locked to the platform via 2 T-profiles, with 2 frontal devices for docking on the transfer trolley</p> <p>4 corner bumpers</p> <p>With adjustable plastic feet</p>	821 x 665 x 335 mm	542 881

Shuttle System 6 StU



1

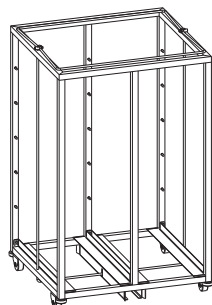

2

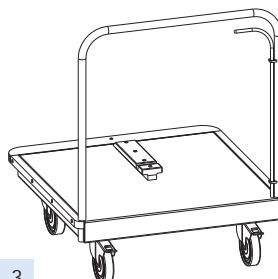

3

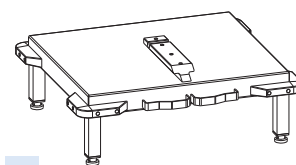

4

	Description	Dimensions (W x D x H)	Item no.
1	Shuttle transport trolley 6 StU		
	<p>Single-wall transport trolley made of CNS 18/10 to hold one slide-in rack 6 StU</p> <p>Guided and locked via a T-profile with frontal docking device</p> <p>2 double-walled folding doors with circumferential seal and stop rail, door with 270° opening angle, lockable at 255° and 270°, lockable via knob</p> <p>4 push handles mounted vertically on the sides</p> <p>4 conductive swivel castors, Ø 160 mm, 2 of them lockable, washing bay compatible, suitable for outdoor transport with full rubber tires</p>	904 x 812 x 1509 mm	542 882
2	6 StU slide-in rack		
	<p>Slide-in rack made of CNS 18/10, 25 x 25 mm rectangular tubing, for storage and transport of 6 StU sterile equipment</p> <p>Safety catch to lock the slide-in rack in the T-profile, 2 sections to hold 6 StU max., 6 pairs of insertable support brackets</p> <p>4 fixed castors, Ø 80 mm, can be sterilized</p>	705 x 635 x 1091 mm	542 428
3	6 StU transfer trolley		
	<p>Transfer trolley made of CNS 18/10 for transport of a 6 StU shuttle slide-in rack</p> <p>The slide-in shelf is guided and locked to the platform via a T-profile, equipped with 1 hook underneath for safe frontal docking of the transfer trolley to the transport trolley</p> <p>1 straight push handle on the long side, three-sided bumper</p> <p>4 conductive swivel castors Ø 160 mm, 2 of them lockable</p>	735 x 734 x 932 mm	542 883
4	Free-standing lower frame for 6 StU		
	<p>Platform made of CNS 18/10 with 4 legs; the 6 StU slide-in rack guided and locked to the platform via 1 T-profile</p> <p>With frontal device for docking to the transfer trolley, 4 corner bumpers</p> <p>With adjustable plastic feet</p>	776 x 665 x 335 mm	542 930

Shuttle System 9 StU

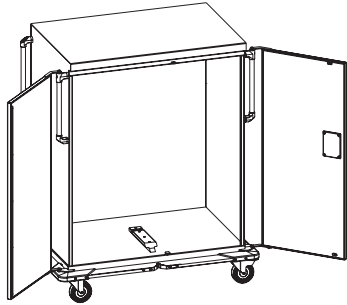

1

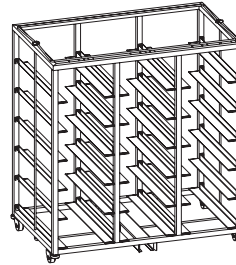

2

	Description	Castors	Dimensions (W x D x H)	Item no.
1	Shuttle transport trolley 9 StU			
	Single-walled transport trolley made of CNS 18/10 to hold one 9 StU slide-in rack; with frontal docking device			
	2 double-walled folding doors with circumferential seal and stop rail, door with 270° opening angle, lockable at 255° and 270°, lockable via knob			
	4 push handles mounted vertically on the sides			
	4 conductive swivel castors, 2 of them lockable, washing bay compatible			
	For 9 StU slide-in rack, mobile in 1 direction, guided and locked via 1 T-profile	Ø 160 mm, suitable for outdoor operation with full rubber tires	1234 x 812 x 1509 mm	542 884
	For 9 StU slide-in rack, mobile in 2 directions, guided and locked via 2 T-profiles	Ø 160 mm	1234 x 774 x 1509 mm	542 885
2	9 StU slide-in rack			
	Sturdy slide-in rack made of CNS 18/10, 25 x 25 mm rectangular tubing, for storage and transportation of 9 StU sterile equipment			
	Safety catch to lock the slide-in shelf in the T-profile,			
	3 sections to hold 9 StU max., 9 pairs of removable support brackets,			
	4 fixed castors, Ø 80 mm, can be sterilized			
	Slide-in rack, mobile in 1 direction		1035 x 635 x 1091 mm	542 466
	Slide-in rack, mobile in 2 directions		1035 x 635 x 1091 mm	542 886

Shuttle System 9 StU

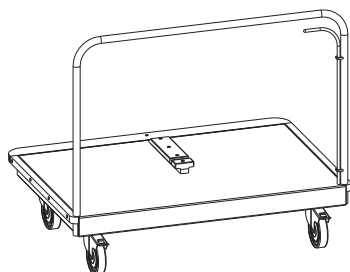

1

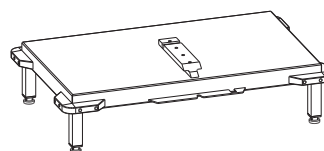

2

	Description	Dimensions (W x D x H)	Item no.
1	9 StU transfer trolley		
	Transfer trolley made of CNS 18/10 for transport of one 9 StU shuttle slide-in rack Equipped with 1 hook underneath for safe frontal docking of the transfer trolley to the transport trolley 1 straight push handle on the long side, three-sided bumper 4 conductive swivel castors Ø 160 mm, 2 of them lockable		
	Mobile in 1 direction, the slide-in rack is guided and locked to the platform via 1 T-profile	1075 x 734 x 932 mm	542 888
	Mobile in 2 directions, the slide-in rack is guided and locked to the platform via two T-profiles, with 2-sided circumferential retaining hoop	1075 x 734 x 932 mm	542 887
2	Free-standing lower frame for 9 StU		
	CNS 18/10 platform with 4 legs 1 slide in racks, 9 StU, guided and locked to the platform via 2 T-profiles with 2 frontal devices to dock the 3 StU transfer trolleys 4 corner bumpers With adjustable plastic feet	1106 x 665 x 335 mm	542 891
	For slide-in rack, mobile in 2 directions	1106 x 665 x 335 mm	542 890

Transport Trolleys

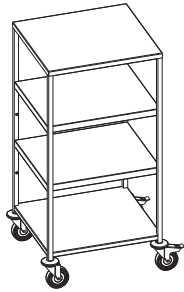

1

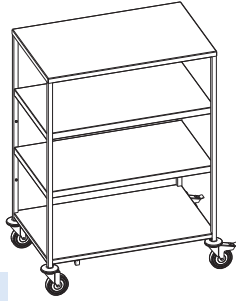

2

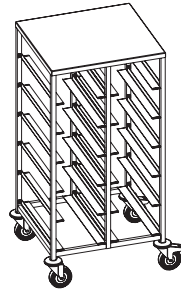

3

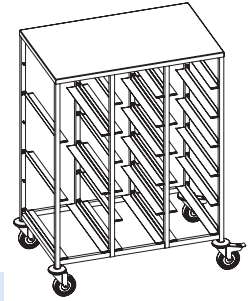

4

	Description	Dimensions (W x D x H)	Item no.
Open transport trolley with shelves			
Open 25 x 25 mm square tubular frame construction, single-walled, made of CNS 18/10 With 2 removable shelves 4 conductive swivel castors Ø 125 mm, 2 of them lockable, with wall deflectors			
1	Holds max. 6 StU sterile equipment	770 x 690 x 1375 mm	542 470
2	Holds max. 9 StU sterile equipment	1100 x 690 x 1375 mm	542 476
Open transport trolley with support brackets			
Open 25 x 25 mm square-type tube frame construction, single-walled, made of CNS 18/10 With 6 pairs of height adjustable support brackets, 4 conductive swivel castors Ø 125 mm, 2 of them lockable, with wall deflectors			
3	Holds max. 6 StU sterile equipment, with 12 pairs of support brackets	770 x 690 x 1375 mm	542 471
4	Holds max. 9 StU sterile equipment, with 15 pairs of support brackets	1100 x 690 x 1375 mm	542 477

Container Transport Trolleys

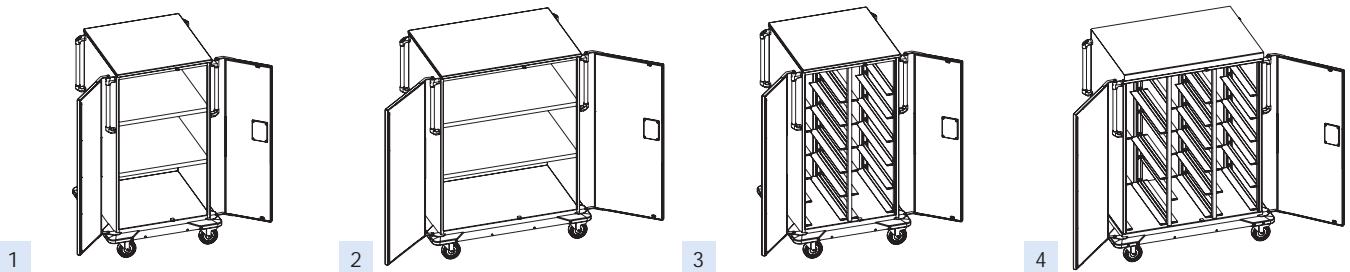

Description	Castors	Dimensions (W x D x H)	Item no.
Enclosed container transport trolley with shelves			
Closed single-walled construction in CNS 18/10, 2 double-walled folding doors with circumferential seal and stop rail, door with opening angle 270°, lockable at 255°, 2 removable shelves, 4 push handles mounted vertically on the sides, 4 corner bumpers, 4 conductive swivel castors, 2 of them lockable, Loading capacity: 200 kg, max. capacity per shelf: 50 kg			
1 Holds max. 6 StU sterile equipment	Castor diameter 125 mm	835 x 810 x 1445 mm	542 472
	Castor diameter 125 mm fully welded, washing bay compatible	845 x 815 x 1475 mm	542 473
	Castor diameter 160 mm Suitable for outdoor use with full rubber tires, washing bay compatible	835 x 810 x 1479 mm	542 925
2 Holds max. 9 StU sterile equipment	Castor diameter 125 mm	1165 x 810 x 1445 mm	542 478
	Castor diameter 125 mm fully welded, washing bay compatible	1175 x 815 x 1475 mm	542 479
	Castor diameter 160 mm Suitable for outdoor use with full rubber tires, washing bay compatible	1165 x 810 x 1479 mm	542 926
Closed container transport trolley with support brackets			
Closed single-walled construction in CNS 18/10 with 12 pairs of height adjustable support brackets, 2 double-walled folding doors with circumferential seal and stop rail, door with opening angle 270°, lockable at 255°, 4 push handles mounted vertically on the sides, 4 corner bumpers, 4 conductive swivel castors, 2 of them lockable, loading capacity: 200 kg			
3 Holds max. 6 StU sterile equipment, 12 pairs of support brackets	Castor diameter 125 mm	835 x 810 x 1445 mm	542 474
	Castor diameter 125 mm Suitable for outdoor use with full rubber tires, fully welded, washing bay compatible	845 x 815 x 1475 mm	542 475
	Castor diameter 160 mm Suitable for outdoor use with full rubber tires, washing bay compatible	835 x 810 x 1479 mm	542 927
4 Holds max. 9 StU sterile equipment, 15 pairs of support brackets	Castor diameter 125 mm	1165 x 810 x 1445 mm	542 480
	Castor diameter 125 mm Suitable for outdoor use with full rubber tires, fully welded, washing bay compatible	1175 x 815 x 1475 mm	542 481
	Castor diameter 160 mm Suitable for outdoor use with full rubber tires, washing bay compatible	1165 x 810 x 1479 mm	542 928

Container Transport Trolleys

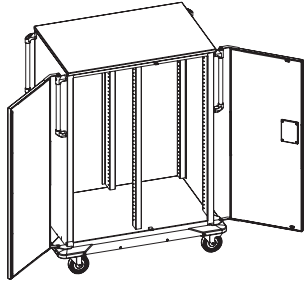

1

Description	Castors	Dimensions (W x D x H)	Item no.
1 Modular transport trolley			
For storage and transport of sterile equipment, enclosed single-walled construction in CNS 18/10, with 2 segments with shot rails for multifunction carrier rails to hold all common ISO modules, 2 double-walled folding doors with circumferential seal and stop rail, door with opening angle 270°, lockable at 255°, 4 push handles mounted vertically on the sides, 4 corner bumpers, 4 conductive swivel castors, 2 of them lockable, Loading capacity: 200 kg			
	Castor diameter 125 mm,	1080 x 810 x 1445 mm	542 482
	Castor diameter 160 mm full rubber tires, washing bay compatible	1080 x 810 x 1479 mm	542 929
Multifunction carrier rails	To hold all common ISO modules, grey white	590 mm long	343 951

Description		Dimensions (W x D x H)	Item no.
Accessories for container transport trolley			
Lock for container transport trolley	Recommended for transportation outside your facility		542 892
Support bracket made of CNS 18/10	As additional equipment		542 893
Shelf for container transport trolley, made of CNS 18/10	As additional equipment		542 894